

# PISTON POSITION SENSING

## ZUB088929

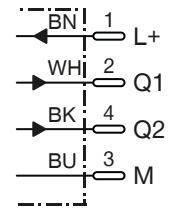

Connection diagram

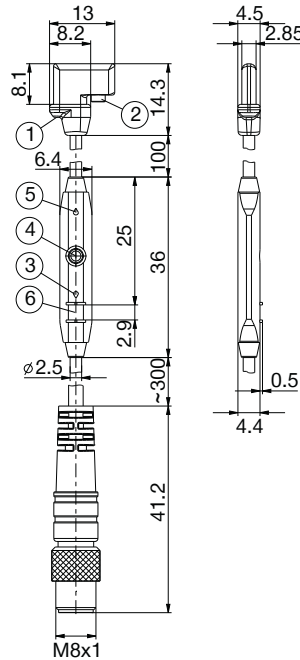

PIN assignment

- ① Center of sensor element
- ② Fixing screw
- ③ Display LED
- ④ Teach-in button
- ⑤ Display LED
- ⑥ Ribs for cable ties

| Order no.                                    | ZUB088929                        |
|--|----------------------------------|
| <b>General data</b>                          |                                  |
| Compatible with installation size            | WWR40                            |
| Cylinder design                              | C-slot                           |
| Switching output                             | PNP                              |
| Switching frequency [Hz]                     | 7000                             |
| Switching function                           | Normally open (NO)               |
| Programmable switching points                | 2                                |
| Electrical version                           | DC 4-wire                        |
| Protection to IEC 60529                      | IP67                             |
| Certification                                | CE                               |
| <b>Electrical / Mechanical data</b>          |                                  |
| Supply voltage min. [V DC]                   | 12                               |
| Supply voltage max. [V DC]                   | 30                               |
| Current consumption [mA]                     | ≤15                              |
| Voltage drop [V]                             | ≤2.2                             |
| Continuous current [mA]                      | ≤100                             |
| Detection zone [mm]                          | Fehlende Variable                |
| Hysteresis typ. [mT]                         | 0.795                            |
| Reproducibility [mT]                         | ≤0.1                             |
| Protected against polarity reversal          | Yes                              |
| Short-circuit-proof                          | Yes                              |
| Power-up pulse protection                    | Yes                              |
| Operating temperature min. [°C]              | -20                              |
| Operating temperature max. [°C]              | +75                              |
| Shock and vibration resistance               | 30 g, 11 ms / 10 ... 55 Hz, 1 mm |
| Housing Material                             | Plastics                         |
| Connection type                              | Cable/Connector                  |
| Fixing thread                                | M8                               |
| Installation type                            | Cable outlet radial              |
| Cable length [m]                             | 0.3                              |
| Nr. of wires x diameter [mm <sup>2</sup> ]   | 4x0.08                           |
| Cable sheath material                        | PUR                              |
| Bending radius for fixed routing, min.       | 3xØ                              |
| Bending radius when using a drag chain, min. | 5xØ                              |