

CHANGEABLE JAW, FIX-PART WB5025F

CHANGEABLE JAW, LOOSE-PART-SET WB5025L

▶ PRODUCT SPECIFICATIONS



5 Changeable jaw, fix-part

4 Changeable jaw, loose-part-set

▶ Technical data

Order no.	WB5025F	WB5025L
Compatible with installation size	GPP5025 / GPD5025	GPP5025 / GPD5025
Tightening torque [Nm]	20	
Packaging unit [piece]	1	2
Weight [kg]	1.5	0.22

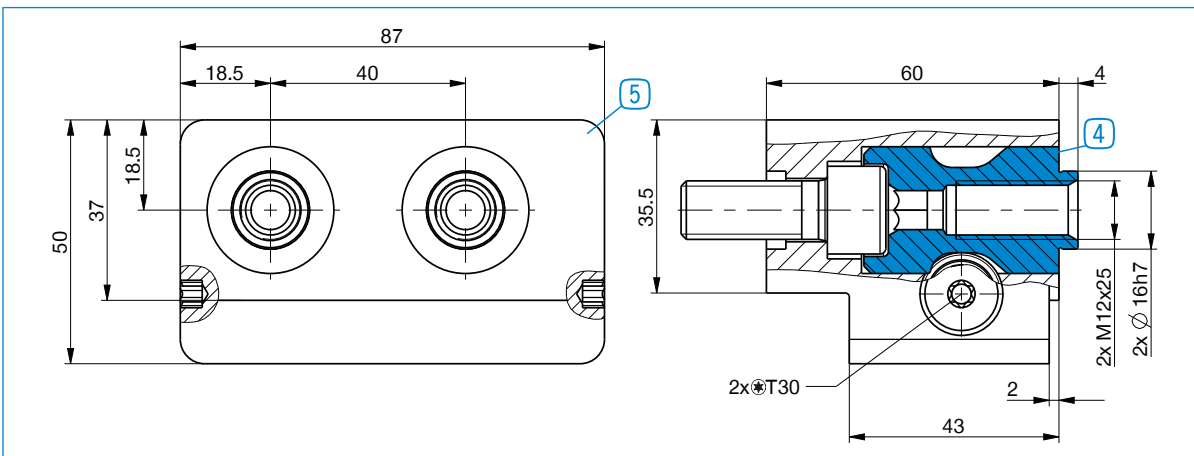

For each gripper jaw, one interchangeable jaw loose part set (4) and one interchangeable jaw fixed part (5) are needed