

ANGLE PIVOT UNITS

SERIES SWM1000

▶ PRODUCT ADVANTAGES

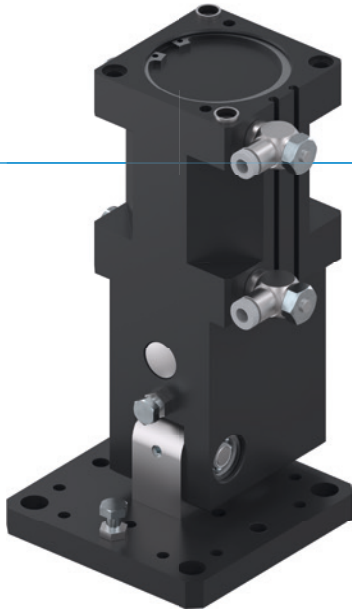

“The slim”

▶ Optimised design

Adjusted to a gantry axle, you can integrate the unit in your machine loading system to save space

▶ Large locating flange

The large mounting surface simplifies your design and allows secure attachment of follow-on tools

▶ Failure-free continuous operation

Our uncompromising “Made in Germany” quality guarantees up to 10 million maintenance-free cycles

▶ SERIES CHARACTERISTICS

Installation size

SWM10XX

 10 million maintenance-free cycles (max.)	●
 IP30	●
 Magnetic field sensor	●
 Powerstop end position damping	●
 Positionability - 2 positions	●



► BENEFITS IN DETAIL

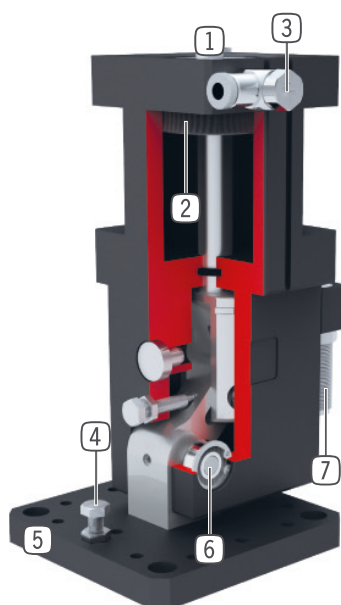

- ① **Mounting and positioning**
- ② **Drive**
 - double-acting pneumatic cylinder
- ③ **Air flow control valve**
 - for speed regulation
 - included in scope of delivery
- ④ **Adjustable end position**
 - +/- 3° adjustable end position
- ⑤ **Intake flange**
 - for connection to application-specific adapter plate (to be supplied by the customer)
- ⑥ **Force transfer 90° pivoting**
 - toggle lever principle
- ⑦ **Patented, hydraulic shock absorber**
 - adjustable end position damping

► TECHNICAL DATA

Installation size	Swivel angle [°]	Torque [Nm]	Weight [kg]	IP class
SWM1035	90	7 - 10	1	IP30
SWM1045	90	14 - 21	1.2	IP30
SWM1054	90	29 - 40	3.6	IP30
SWM1063	90	39 - 64	3.5	IP30
SWM1080	90	88 - 150	5.5	IP30

► FURTHER INFORMATION IS AVAILABLE ONLINE



All information just a click away at: www.zimmer-group.com. Find data, illustrations, 3D models and operating instructions for your installation size using the order number for your desired product. Quick, clear and always up-to-date.

ANGLE PIVOT UNITS

INSTALLATION SIZE SWM1063

▶ PRODUCT SPECIFICATIONS



▶ Moment of inertia

Shows the torque when lifting vs the swivel angle.

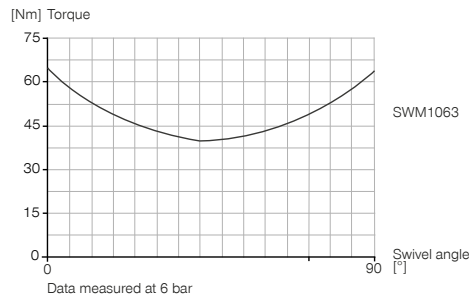

▶ Forces and moments

Indicates the static load on the bearing.

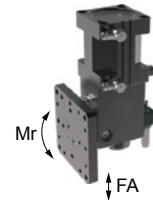

Fa [N]	500
Mr [Nm]	45

▶ INCLUDED IN DELIVERY



2 [piece]
Flow Control Valves - with Swivel joint
DRV1-8X6



2 [piece]
Centering Disc
DST42000

▶ RECOMMENDED ACCESSORIES



ENERGY SUPPLY



DSV1-8
Pressure safety valve



DSV1-8E
Pressure safety valve with quick exhaust



SENSORS



MFS01-K-KHC-P1-PNP
Magnetic field sensor angled, cable 5 m



MFS01-S-KHC-P1-PNP
Magnetic field sensor angled, cable 0.3 m - M8 connector



MFS02-K-KHC-P1-PNP
Magnetic field sensor straight, cable 5 m



MFS02-S-KHC-P1-PNP
Magnetic field sensor straight, cable 0.3 m - M8 connector



CONNECTIONS / OTHER



ANS0049
Attachment Kit



PHE14X10NHDE-A
Industrial shock absorbers PowerStop



KAG500
Plug-in connector Straight Cable 5m - female connector M8



KAW500
Plug-in connector Angled Cable 5m - female connector M8



S8-G-3
Plug-in connector customizable Straight - male connector M8

Order no.	Technical data
	SWM1063
Swivel angle [°]	90
Swivel angle regulable +/- [°]	3
Torque 0° [Nm]	64
Torque 45° [Nm]	39
Torque 90° [Nm]	64
Repetition accuracy +/- [°]	0.01
Swivel time without extension load [s]	0.6
Operating pressure min. [bar]	3
Operating pressure max. [bar]	8
Nominal operating pressure [bar]	6
Operating temperature min. [°C]	5
Operating temperature max. [°C]	+80
Air volume per cycle [cm³]	340
Certifications	LABS / REACH / RoHS
Protection to IEC 60529	IP30
Weight [kg]	3.5

