

SWIVEL JAWS

SERIES SBZ

▶ PRODUCT ADVANTAGES

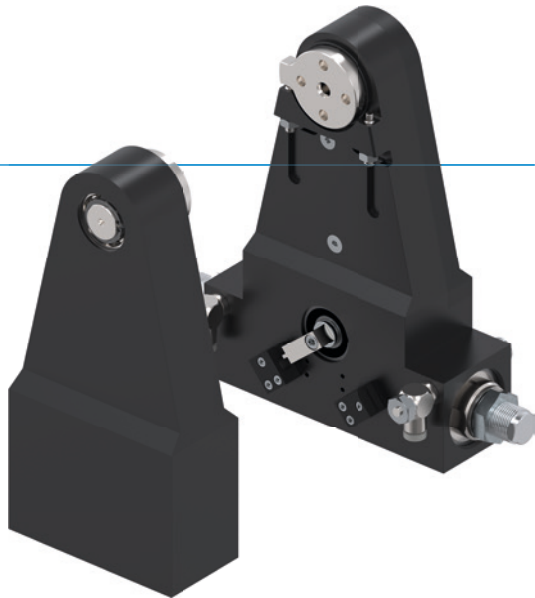

“The superior”

▶ Shock absorber with spiral groove technology

Superior end position damping lets you swivel more mass in the shortest amount of time, increasing your machine's component output











▶ Force transmission via gear wheel set

The robust gear wheels stand for precision, reliability and long service life and guarantee smooth operation

▶ Failure-free continuous operation

Our uncompromising “Made in Germany” quality guarantees up to 10 million maintenance-free cycles

▶ SERIES CHARACTERISTICS

Installation size	Version		
SBZXXX	-90	-180	G
 10 million maintenance-free cycles (max.)	●	●	
 IP54	●	●	
 Inductive sensor	●	●	
 Flange	●	●	●
 Powerstop end position damping	●	●	
 End positions adjustable +/- 3°	●	●	
 Positionability - 2 positions	●	●	
 Rotation angle 90°	●		●
 Rotation angle 180°		●	●
 Counter bearing without drive			●



► BENEFITS IN DETAIL



- ① **Two way bearing drive shaft**
 - high forces and moments capacity
- ② **Drive flange**
 - large size drive flange with end stop and large central hole (from SB150)
- ③ **Force transfer**
 - stable gear wheel set
 - precise, reliable, durable
- ④ **Position sensing**
 - inquiry of end positions 0° and 90° (or 180°) via inductive proximity switch
 - adjustable on rotatable switch cam
- ⑤ **Drive**
 - double-acting pneumatic cylinder
- ⑥ **Air flow control valve**
 - for speed regulation (included in the delivery)
- ⑦ **Mounting and positioning**
 - mounting possible from several sides for versatile positioning
- ⑧ **Integrated and patented hydraulic shock absorbers**
 - adjustable end position damping

► TECHNICAL DATA

Installation size	Swivel angle [°]	Torque [Nm]	Weight [kg]	IP class
SB50	90 - 180	1,2	0,47 - 0,78	IP54
SB74	90 - 180	3,5	1,1 - 1,9	IP54
SB100	90 - 180	10	2,7 - 4,3	IP54
SB150	90 - 180	23	6,6 - 11	IP54
SB190	90 - 180	57	20 - 26	IP54

► FURTHER INFORMATION IS AVAILABLE ONLINE



All information just a click away at: www.zimmer-group.com. Find data, illustrations, 3D models and operating instructions for your installation size using the order number for your desired product. Quick, clear and always up-to-date.

SWIVEL JAWS

INSTALLATION SIZE SB190

▶ PRODUCT SPECIFICATIONS



▶ Moment of inertia

[kg m²] Shows the expected swivel time against the calculated moment of inertia

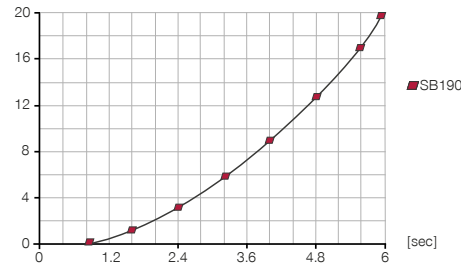

▶ Forces and moments

Indicates the static load on the bearing.



Fa [N]	25000
Mr [Nm]	600
FD [N]*	12500
FZ [N]*	6100

▶ INCLUDED IN DELIVERY



2 [piece]
Mounting block
KB12-03



2 [piece]
Flow Control Valves - with Swivel joint
DRV1-4X8

▶ RECOMMENDED ACCESSORIES



ENERGY SUPPLY



DSV1-8
Pressure safety valve



DSV1-8E
Pressure safety valve with quick exhaust



SENSORS



NJ12-E2
Inductive proximity switch - Cable 5 m



NJ12-E2S
Inductive proximity switch - Connector M8



CONNECTIONS / OTHER



KAG500
Plug-in connector Straight Cable 5m - Socket M8 (female)



KAW500
Plug-in connector Angled Cable 5m - Socket M8 (female)



S8-G-3
Plug-in connector customizable Straight - Connector M8



S12-G-3
Plug-in connector customizable Straight - Connector M12

Order no.	► Technical data		
	SB190-90	SB190-180	SB190G
Swivel angle [°]	90	180	
Torque per jaw [Nm]	57	57	
Swivel angle regulable +/- [°]	3	3	
Repetition accuracy +/- [°]	0.01	0.01	
Operating pressure min. [bar]	3	3	
Operating pressure max. [bar]	8	8	
Nominal operating pressure [bar]	6	6	6
Operating temperature min. [°C]	5	5	5
Operating temperature max. [°C]	+80	+80	+80
Air volume per cycle [cm³]	320	320	
Protection to IEC 60529	IP54	IP54	IP54
Weight [kg]	26	25	20
FD [N]*	12500	12500	12500
FZ [N]*	6100	6100	6100

*Observe the gripper force

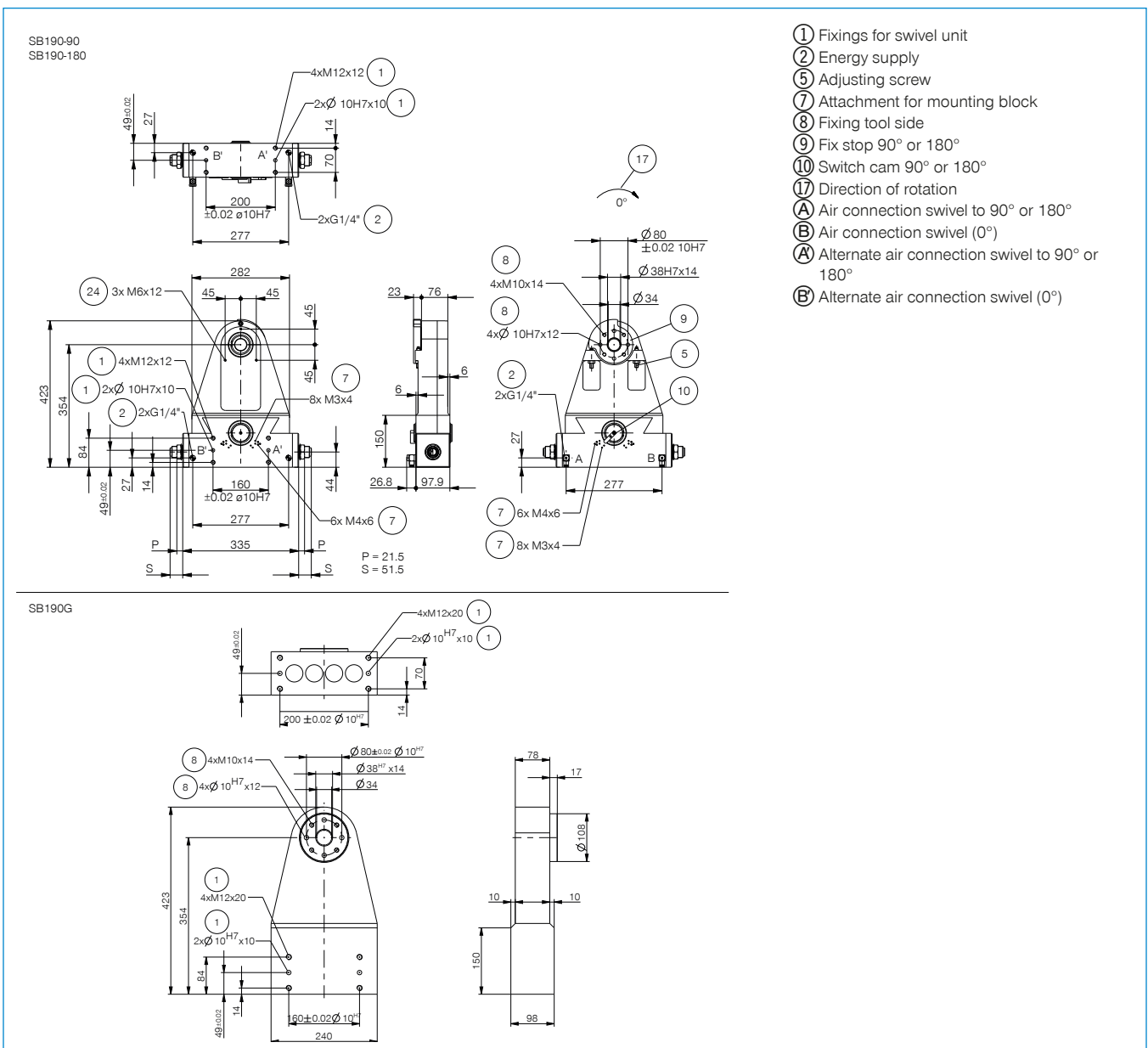

SWIVEL JAWS

SERIES SBZ FUNCTIONAL DESCRIPTION



ENERGY SUPPLY

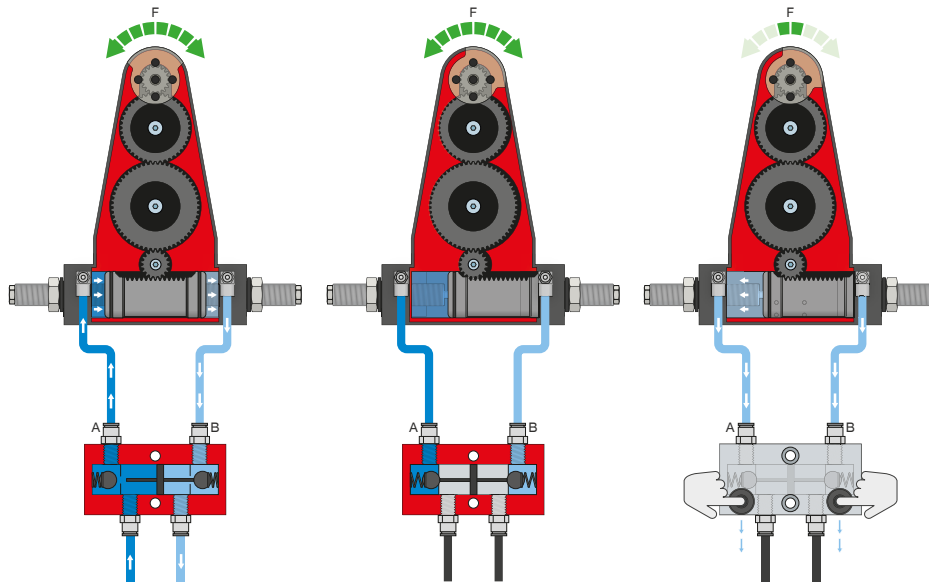

Pressure safety valve – DSV

Ensures safe retention of force and position if the system pressure drops

The integrated double check valve, which can be unlocked, retains the system pressure of the swivel jaw in case of EMERGENCY STOP. To ensure the function, the valve must be installed as close to the swivel jaw's air connection as possible. In variant E, two pushbuttons are installed that allow for controlled bleeding of the swivel jaw.



SENSORS

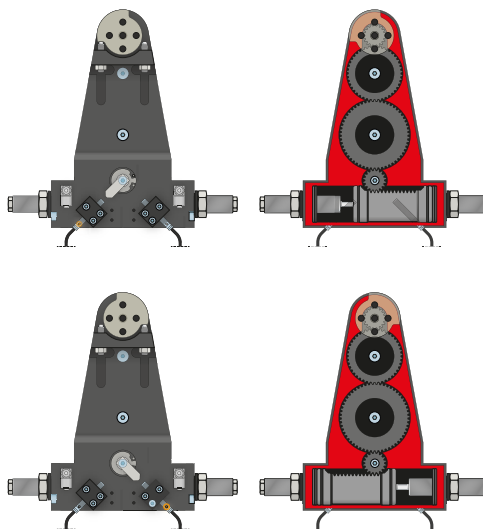

Inductive sensors – NJ

The sensor is inserted into the mounting block as far as it will go and secured. Tuning to the desired position then takes place by adjusting the cam switch. The sensors are available in versions with 5 m cables with exposed leads and 0,3 m cable with connector, as well as with direct plug orientation.



CONNECTIONS / OTHER

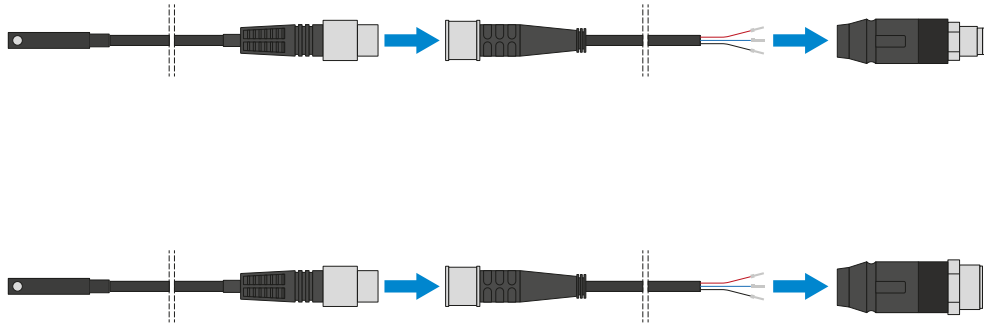

Plug-in connectors

For extending and fabricating the connection lines for the sensors

Cables with a length of 5 m with exposed leads are available. Depending on the specific needs, the cables can be shortened or fabricated with connectors in sizes M8 and M12.