

# INDUCTIVE PROXIMITY SWITCH

## SENSOR STOP SLEEVE | PSH

Accessories	
<b>General data</b>	
Certification	CE / UKCA / cULus / WEEE
Basic standard	IEC 60947-5-2
Protection to IEC 60529	IP67
Function display	Yes
Protected against polarity reversal	Yes
Power indicator	No
Short-circuit-proof	Yes
<b>Electrical data</b>	
Connection type	Cable
Effective operating voltage [V DC]	24
Rated insulation voltage [V DC]	75
Load current capacity [mA]	150
Rated short circuit current [A]	100
Supply voltage min. [V DC]	10
Supply voltage max. [V DC]	30
Electrical version	DC, direct current
Minimum operating current [mA]	1
Load capacitance max. [ $\mu$ F]	0.2
No-load current damped max. [mA]	3
Max. no-load current undamped [mA]	9
Ripple max. [%]	10
Switching output	PNP
Switching frequency [Hz]	3000
Switching function	Normally closed contact (NC)
Voltage drop [V]	2.5
<b>Mechanical data</b>	
Nr. of wires x diameter [mm <sup>2</sup> ]	3x0.073
Rated operating distance $S_n$ [mm]	2.00
Installation type	flush
Housing Material	Stainless steel
Assured switching distance $S_a$ [mm]	1.60
Cable- $\varnothing$ D [mm]	2.1
Cable length [m]	2
Effective operating distance $S_r$ [mm]	2
Depth [mm]	10
Ambient temperature range [°C]	-25 ... +70
Active surface material	PBT
Cable sheath material	PUR

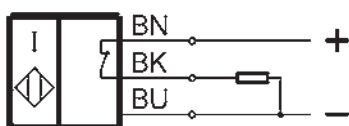
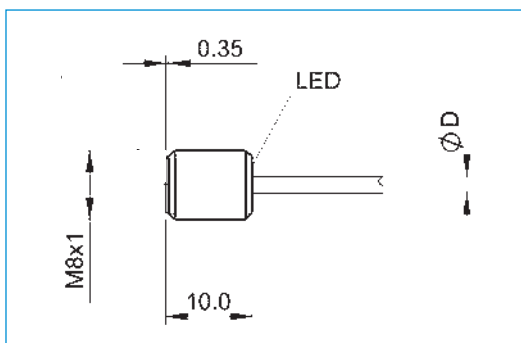

# POWERSTOP INDUSTRIAL SHOCK ABSORBER ACCESSORIES

## STOP SLEEVE | PAH



### Available for M4-M36

It is advisable to use a stop sleeve for optimal damping stroke adjustment. In this process, the end stop and the damping stroke can be adjusted individually by screwing the sleeve on the shock absorber external thread using the additional lock nut.

It is advisable to start by setting the ideal utilization of the damper by reducing the damping stroke. The end stop can subsequently be set using the position of the damper in the mounting piece.

The stop sleeve works either with or without a steel and plastic head, but not in conjunction with the bellow. The stop sleeve, including the additional lock nut contained in the scope of delivery, is made of stainless steel.

## SENSOR STOP SLEEVE | PSH



### Available for M8-M33 (with the exception of M16, M22 and M27)

In addition to the stop sleeve features, the sensor stop sleeve features inductive sensor with highly compact integration for sensing the end position of the set damping stroke. Using the sensor stop sleeve requires the use of an industrial shock absorber with a steel or plastic head (excluding the bellow).

Inductive sensor, PNP (NC), 2 m PUR cable, IP67 degree of protection.

See separate data sheet for additional information.

## SIDE LOAD ADAPTER | PBV



### Available for M8-M36 for normal and long stroke

If the industrial shock absorber is actuated with a higher angle of impact than the permissible misalignment of  $2^\circ$ , then a side load adapter must be provided. This increases the permissible angle of impact to  $30^\circ$ , which is especially advantageous for rotative applications. The side load adapter can only be used in combination with an industrial shock absorber without a head. Here, the damper can alternatively be screwed on using the external thread of the side load adapter.

Consisting of a piston rod and housing made of stainless steel, the side load adapter is available in two protection configurations.

#### **Protection: no protection**

in a clean environment

#### **Protection: Wiper**

Against liquids and oil

#### **Protection: Felt ring**

Against dust and chips

## CLAMPING FLANGE SCREWED ON ORTHOGONALLY | PKS



### Available for M8-M36

You can use a clamping flange made of nickel-plated steel to connect the shock absorber to the structure more easily. After being fully screwed in, the shock absorber is clamped tightly to the clamping flange by screwing at a right angle to the shock absorber and fastened to the structure, which makes the locknut unnecessary.

## CLAMPING FLANGE SCREWED PARALLEL | PKP



### Available for M8-M36

You can use a clamping flange made of nickel-plated steel to connect the shock absorber to the structure more easily. After being fully screwed in, the shock absorber is clamped tightly to the clamping flange by screwing in the screwing direction of the shock absorber and fastened to the structure, which makes the locknut unnecessary.

## LOCKNUT | PVM



### Available for M4-M36

A nut made of stainless steel is supplied for each industrial shock absorber. When installing in a drilled hole with no threading, an additional nut for attachment on both sides can be ordered at the same time.

## PRESSURE CHAMBER SEAL | PDD



### Available for M4-M36

If the industrial shock absorber is being used within a pressure chamber, for instance in a pneumatic cylinder or a swivel unit, then a pressure chamber seal is required for sealing the outer contour of the shock absorber. For ideal sealing, the seal must make full-surface contact on both sides. The seal itself is made of NBR, which is applied to corrosion-protected galvanised steel for stabilization purposes.

# INDUSTRIAL SHOCK ABSORBERS POWERSTOP THREAD M14X1.5

## ► SERIES

PowerStop®



► <b>Material</b>	Stainless steel	► <b>Organic oil (biodegradable)</b>	HEES
► <b>Permitted temperature range</b>	-10 ... +70 [°C]	- <b>H1-certified</b>	Yes
► <b>Angle of Impact max.</b>	2 [°]	- <b>PWIS-free</b>	Yes
► <b>Max. force at fixed stop</b>	3.5 [kN]	► <b>RoHS compliant</b> - <b>REACH compliant</b>	Yes
► <b>Lock nut tightening torque</b>		► <b>Max. absolute pressure</b>	
- <b>Standard energy</b>	15 [Nm]	- <b>Standard energy</b>	1 [bar]
- <b>High Energy</b>	20 [Nm]	- <b>High Energy</b>	10 [bar]
- <b>Adjustable Energy</b>	20 [Nm]	- <b>Adjustable Energy</b>	10 [bar]

## ► TECHNICAL DATA

	Design	Series	Thread	Stroke variant	Stroke max. [mm]	Hardness degree	Impact velocity		Energy absorption max.			Protection	Reset			Head Integrated Fix stop	Version				
							min.	max.	Continuous operation		Emergency stop operation		Force min. [N]	Time max. [s]							
									per stroke [J]	per hour [J/h]					per stroke [J]						
STANDARD ENERGY	P	SE	14X15	N	12	H	0,1	1,2	20	50.000	20	D	3	6	0,3	D	x				
							M	0,8	2,2	20	50.000		20	F	3			6	0,3	E	-
							S	1,8	3,5	20	50.000		20	A	3			6	0,3	S	x
							W	3,0	5,0	20	50.000		20	B	3			15	0,3	K	x
HIGH ENERGY	P	HE	14X15	N	12	H	0,1	1,2	34	50.000	42	D	7	11	0,3	D	x				
							M	0,8	2,2	32	50.000		38	F	7			11	0,3	E	-
							S	1,8	3,5	30	50.000		34	A	7			11	0,3	S	x
							W	3,0	5,0	28	50.000		30	B	7			20	0,3	K	x
ADJUSTABLE ENERGY	P	AE	14X15	N	12	H	0,1	5,0	34	50.000	34	D	7	11	0,3	D	x				
							M	0,8	2,2	32	50.000		38	F	7			11	0,3	E	-
							S	1,8	3,5	30	50.000		34	A	7			11	0,3	S	x
							W	3,0	5,0	28	50.000		30	B	7			20	0,3	K	x
HIGH ENERGY	P	HE	14X15	L	20	H	0,1	1,2	34	50.000	42	D	7	11	0,4	D	x				
							M	0,8	2,2	32	50.000		38	F	7			11	0,4	E	-
							S	1,8	3,5	30	50.000		34	A	7			11	0,4	S	x
							W	3,0	5,0	28	50.000		30	B	7			11	0,4	K	x
ADJUSTABLE ENERGY	P	AE	14X15	L	20	H	0,1	5,0	34	50.000	34	D	7	11	0,4	D	x				
							M	0,8	2,2	32	50.000		38	F	7			11	0,4	E	-
							S	1,8	3,5	30	50.000		34	A	7			11	0,4	S	x
							W	3,0	5,0	28	50.000		30	B	7			11	0,4	K	x

## PROTECTION

no protection	Felt ring	Wiper (NBR)	Bellow (TPE)
D -A	F -A	A -A	B -A
in a clean environment	against dust, chips, ...	against liquid, oil, ...	

## TECHNICAL DRAWINGS

	Short piston rod no head	Long piston rod no head	with steel head	with plastic head	with bellow and steel head	with bellow and plastic head
	N D -A	N E -A	N S -A	N K -A	N B S -A	N B K -A
STANDARD ENERGY						
HIGH ENERGY						
ADJUSTABLE ENERGY						

	Short piston rod no head	Long piston rod no head	with steel head	with plastic head
	L D -A	L E -A	L S -A	L K -A
HIGH ENERGY				
ADJUSTABLE ENERGY				



# INDUSTRIAL SHOCK ABSORBERS POWERSTOP

## THREAD M14X1.5

### ▶ ACCESSORIES

Pos.	Order no.	Accessories	Remarks
①	<b>PAH14X15-A</b>	Stop sleeve	Including 1x PVM14X15-A. Industrial shock absorber with bellow excluded.
②	<b>PSH14X15-B</b>	Sensor stop sleeve	Including 1x PVM14X15-A. Sensing only possible via industrial shock absorbers with steel or plastic head. Industrial shock absorber with bellow excluded. Inductive sensor, PNP (NC), 2 m PUR cable, IP67 degree of protection. See separate data sheet for additional information.
③	<b>PBV14X15ND-A</b>	Side load adapter standard stroke Protection: no protection	Impact angle max. 30°. Can only be used in combination with industrial shock absorber without protection and without the Short piston rod no head variant. Lock nut PVM20X15-A suitable for external thread of the side load adapter.
④	<b>PBV14X15NF-A</b>	Side load adapter standard stroke Protection: felt ring (felt)	Impact angle max. 30°. Can only be used in combination with industrial shock absorber without protection and without the Short piston rod no head variant. Lock nut PVM20X15-A suitable for external thread of the side load adapter.
⑤	<b>PBV14X15NA-A</b>	Side load adapter standard stroke Protection: wiper (NBR)	Impact angle max. 30°. Can only be used in combination with industrial shock absorber without protection and without the Short piston rod no head variant. Lock nut PVM20X15-A suitable for external thread of the side load adapter.
⑥	<b>PBV14X15LD-A</b>	Side load adapter long stroke Protection: no protection	Impact angle max. 30°. Can only be used in combination with industrial shock absorber without protection and without the Short piston rod no head variant. Lock nut PVM20X15-A suitable for external thread of the side load adapter.
⑦	<b>PBV14X15LF-A</b>	Side load adapter long stroke Protection: felt ring (felt)	Impact angle max. 30°. Can only be used in combination with industrial shock absorber without protection and without the Short piston rod no head variant. Lock nut PVM20X15-A suitable for external thread of the side load adapter.
⑧	<b>PBV14X15LA-A</b>	Side load adapter long stroke Protection: wiper (NBR)	Impact angle max. 30°. Can only be used in combination with industrial shock absorber without protection and without the Short piston rod no head variant. Lock nut PVM20X15-A suitable for external thread of the side load adapter.
⑨	<b>PKS14X15-A</b>	Clamping flange orthogonal screwed	Tightening torque of the screws max. 5 Nm.
⑩	<b>PKP14X15-A</b>	Clamping flange screwed in parallel	Tightening torque of the screws max. 3 Nm.
⑪	<b>PVM14X15-A</b>	Stainless steel locknut	Included with the industrial shock absorber.
⑫	<b>PDD14X15-A</b>	Pressure chamber seal	Recommended fixation with PVM14X15-A. Seal must be in full contact on both sides.

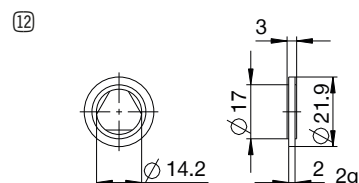
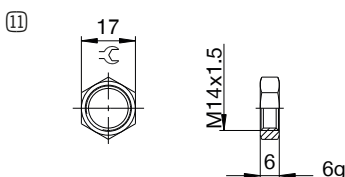
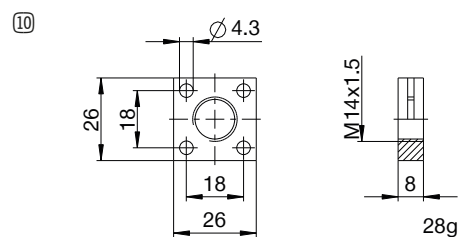
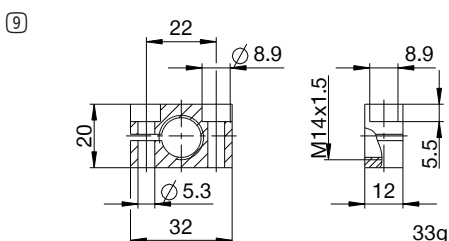
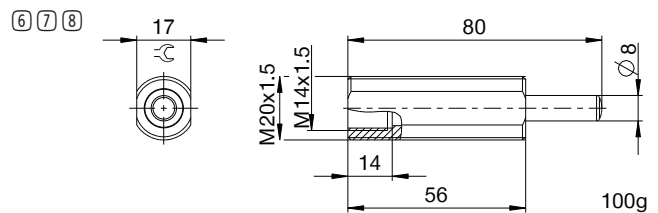
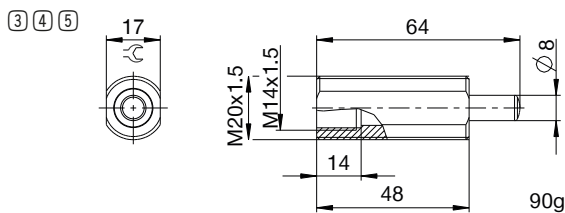
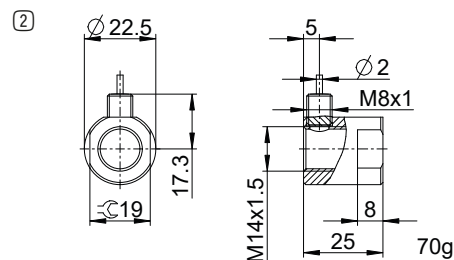
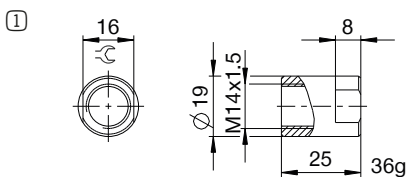

## ▶ CLASSIFICATION

P HE 14X15 L H A K -A

### Design

**P** Industrial shock absorbers PowerStop

### Series

**ME** Mini Energy

**SE** Standard Energy

**HE** High Energy

**AE** Adjustable Energy

### Thread

**14** Thread nominal diameter

**X**

**15** Thread pitch (factor 10)

### Stroke variant

**N** Standard stroke

**L** Long stroke

### Hardness degree

**H** Hard (0.1 - 1.2 m/s; Adjustable Energy: 0.1 - 5 m/s)

**M** Medium (0.8 - 2.2 m/s)

**S** Soft (1.8 - 3.5 m/s)

**W** Supersoft (3 - 5 m/s)

### Protection

**D** no protection

**F** Felt ring

**A** Wiper (NBR)

**B** Bellow (TPE)

### Head

**D** Short piston rod no head

**E** Long piston rod no head

**S** with steel head

**K** with plastic head

### Version

**-A** Versioning from a to z