

# ROTARY CYLINDERS

## SERIES PRN

### ▶ PRODUCT ADVANTAGES

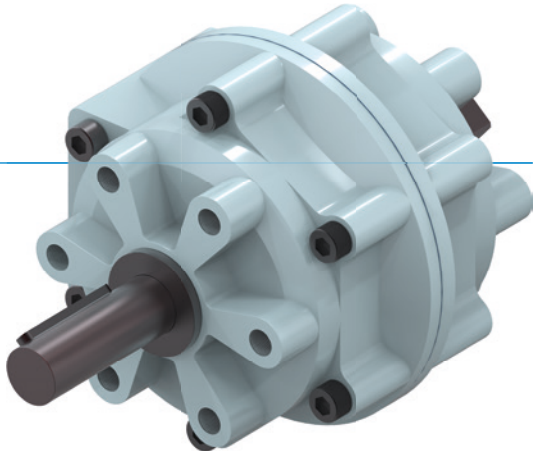

#### “The economical”

##### ▶ Concentration on the essentials

The most economic type of swivelling reduces your production costs







##### ▶ Dampened end position

Using the hydraulic brake allows you to move up to the end positions gently, increasing the process reliability and durability of your application

##### ▶ Forged drive shaft

This shaft is not only robust, but can be individually adjusted

### ▶ SERIES CHARACTERISTICS

Installation size		Version				
PRNXXX		-90	-100	-180	-270	-280
 1.5 million maintenance-free cycles (max.)		•	•	•	•	•
 IP54		•	•	•	•	•
 Inductive sensor		•	•	•	•	•
 Positionability - 2 positions		•	•	•	•	•
 Rotation angle 90°		•				
 Rotation angle 180°				•		
 Rotation angle 270°					•	



## ▶ STARTING ANGLE



- ① Starting angle
- ② Swivel angle



### Installation size

PRN1	PRN20
PRN3	PRN30
PRN10	PRN50
	PRN150
	PRN300
	PRN800

## ▶ TECHNICAL DATA

Installation size	Swivel angle [°]	Torque [Nm]	Weight [kg]	IP class
PRN1	90 - 270	0,15	0,04	IP54
PRN3	90 - 270	0,38	0,07	IP54
PRN10	90 - 270	1,2	0,14	IP54
PRN20	90 - 270	2,1	0,25	IP54
PRN30	90 - 270	4,1	0,5	IP54
PRN50	90 - 270	5,9 - 12,8	0,75 - 0,8	IP54
PRN150	90 - 270	18 - 41,5	1,6 - 1,9	IP54
PRN300	90 - 270	34,5 - 83	3,6 - 4,1	IP54
PRN800	90 - 270	123 - 247	12 - 13	IP54

## ▶ FURTHER INFORMATION IS AVAILABLE ONLINE



All information just a click away at: [www.zimmer-group.com](http://www.zimmer-group.com). Find data, illustrations, 3D models and operating instructions for your installation size using the order number for your desired product. Quick, clear and always up-to-date.

# ROTARY CYLINDERS

## INSTALLATION SIZE PRN10

### ▶ PRODUCT SPECIFICATIONS



#### ▶ Moment of inertia

[kg cm<sup>2</sup>] Shows the expected swivel time vs the calculated moment of inertia

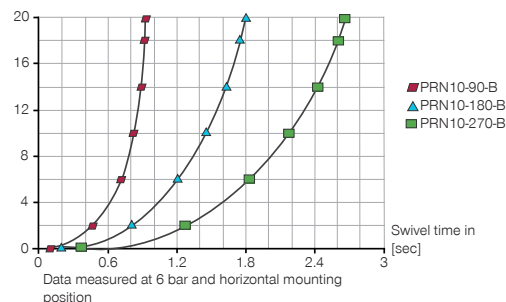

#### ▶ Forces and moments

Shows the maximum static shaft load.

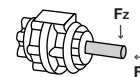

FY [N]	4
FZ [N]	50

### ▶ RECOMMENDED ACCESSORIES



#### ENERGY SUPPLY



**GVM5**  
Straight Fittings - Quick Connect Style



**DRVM5X4**  
Flow Control Valves - with Swivel joint



**DSV1-8**  
Pressure safety valve



**DSV1-8E**  
Pressure safety valve with quick exhaust



#### CONNECTIONS / OTHER



**F10-P**  
Flange



**F10-LB**  
Angle flange



**DB10**  
Rotation limiter

### ▶ RECOMMENDED ACCESSORY ROTATION LIMITER



**AI-M8X1-38**  
Stop Stroke Adjustment Screws



**NJ12-E2S**  
Inductive proximity switch - Connector M8



**NJ12-E2**  
Inductive proximity switch - Cable 5 m



**KAW500**  
Plug-in connector Angled Cable 5m - Socket M8 (female)

Order no.	► Technical data		
	PRN10-90-B	PRN10-180-B	PRN10-270-B
Swivel angle [°]	90	180	270
Tolerance swivel angle [°]	0° / +4°	0° / +4°	0° / +4°
Starting Angle [°]	90	90	45
Torque [Nm]	1.2	1.2	1.2
Swivel time [s]	0.13	0.2	0.28
Operating pressure min. [bar]	2	2	2
Operating pressure max. [bar]	7	7	7
Nominal operating pressure [bar]	6	6	6
Operating temperature min. [°C]	-5	-5	-5
Operating temperature max. [°C]	+80	+80	+80
Air volume per cycle [cm <sup>3</sup> ]	19.6	19.6	19.6
Protection to IEC 60529	IP54	IP54	IP54
Weight [kg]	0.15	0.15	0.15

- ① Energy supply
- ② Fixing Rotor
- Ⓐ Air connection (0°-90°/180°/270°)
- Ⓑ Air connection (90°/180°/270°-0°)
- Ⓐ Alternate air connection 0°-90°/180°/270°
- Ⓑ Alternate air connection 90°/180°/270°-0°

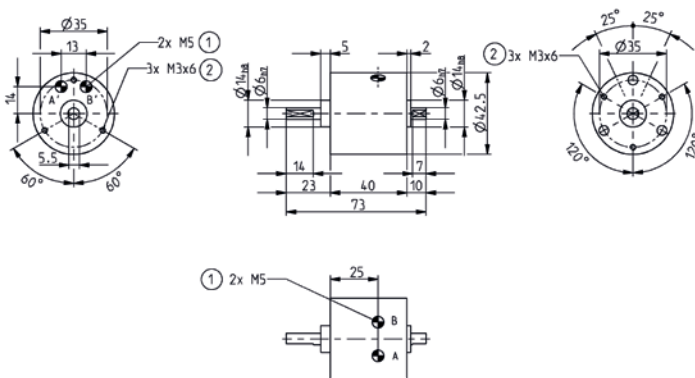

# ROTARY CYLINDERS

## ACCESSORIES SERIES PRN

### ► OIL DAMPER FOR PNEUMATIC ROTOR



#### ► Technical data

Order no.	CRN50	CRN150	CRN300
suitable for	PRN50	PRN150	PRN300
Brake angle [°]	11	12	14
Energy absorption per stroke max. [Nm]	3	10	20
Energy absorption per stroke max. [Nm/h]	12000	43200	84000
Operating temperature min. [°C]	5	5	5
Operating temperature max. [°C]	50	50	50
Weight [g]	240	420	780

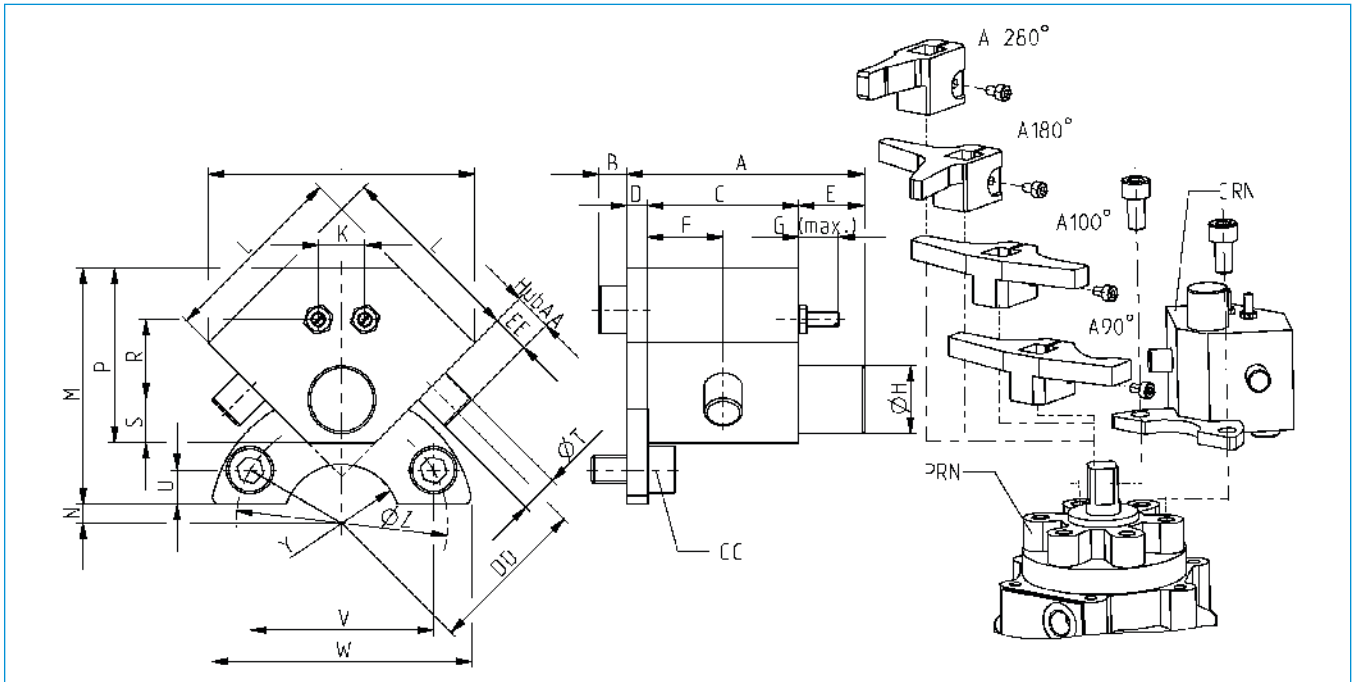

Order no.	A	B	C	D	E	F	G	H	J	K	L	M	N	P	R	S	T	U	V	W	Y	Z	AA	CC	DD	EE
	[mm]	[mm]	[mm]	[mm]	[mm]	[mm]	[mm]	[mm]	[mm]	[mm]	[mm]	[mm]	[mm]	[mm]	[mm]	[mm]	[mm]	[mm]	[mm]	[mm]	[mm]	[mm]	[mm]	[mm]	[mm]	[mm]
<b>CRN50</b>	50.6	6.0	3.2	4.5	14	16	8.5	Ø14,4	56.6	9.9	40	50	4.0	37	17.0	9.2	Ø8	7.2	39.0	56	R12,5	Ø45	6.5	M6x1x12	34	8
<b>CRN150</b>	56.5	7.2	3.6	4.5	16	18	8.5	Ø18,4	70.7	11.3	50	62	9.5	49	25.5	11.4	Ø10	8.0	60.6	80	R15,0	Ø70	10.0	M8x1,25x16	46	12
<b>CRN300</b>	62.5	7.2	4.2	4.5	16	21	12.0	Ø22,5	91.9	12.7	65	87	8.0	61	33.2	14.1	Ø12	12.0	69.2	95	R22,5	Ø80	15.0	M10x1,5x20	62	18

## ▶ STOP LEVER FOR OIL DAMPER



## ▶ STOP LEVER PRN50

### ▶ Technical data

Order no.	A50-90-B	A50-180-B	A50-270
Swivel angle [°]	90	180	270

## ▶ STOP LEVER PRN150

### ▶ Technical data

Order no.	A150-90-B	A150-180-B	A150-270
Swivel angle [°]	90	180	270

## ▶ STOP LEVER PRN300

### ▶ Technical data

Order no.	A300-90-B	A300-180-B	A300-270
Swivel angle [°]	90	180	270