

线性气缸

LI 系列

▶ 产品优点

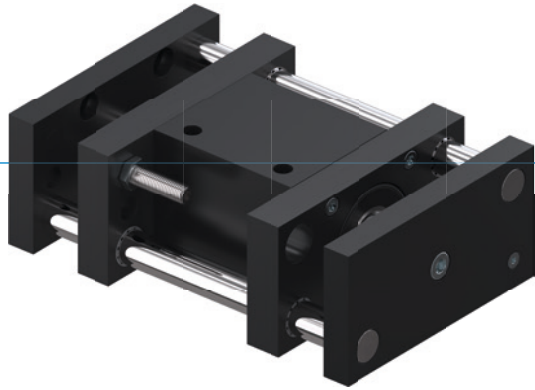

▶ 大定位法兰

大连接面简化了您的设计并且可牢固连接后续工具









▶ 终端位置缓冲

摆到最终位置时用液压缓冲器平缓缓冲, 这样使您的生产更稳定, 应用使用寿命更长

▶ 无间断的持续工作

“德国制造”象征着我们精益求精的质量要求, 保证免维护运行一千万次循环

▶ 产品特点

尺寸型号	版本		
	LIXX	D	S
 2路导向			●
 3路导向		●	
 通用活塞杆		●	
 (最多)1千万次循环免维护	●	●	●
 接近传感器	●	●	●
 弹性体终端位置减振装置	●	●	●
 Powerstop 终端位置减振装置	●	●	●
 IP54	●	●	●



优势细节

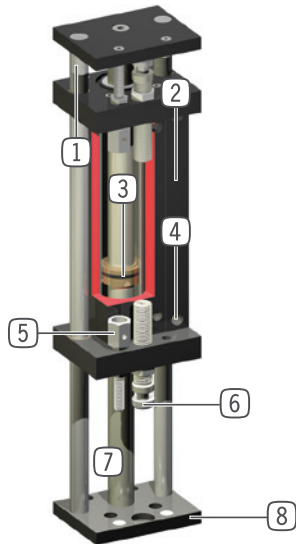

- ① **导轨**
 - 抛光的加固钢杆
- ② **安装块**
 - 安装接近开关
- ③ **驱动**
 - 双作用气缸
- ④ **能源供应**
 - 减少排气时间
- ⑤ **终端位置确认螺丝**
 - 直接检测法兰位置
 - 随厂包括
- ⑥ **最终位置缓冲**
 - 用塑料缓冲器或专利技术的油压缓冲器
- ⑦ **活塞杆**
 - 抛光镀硬铬钢
 - D型号里面是一体的
- ⑧ **工具端连接法兰**
 - 用于特定应用的连接板(由客户提供)

技术数据

尺寸型号	行程 [mm]	压力 [N]	最大收缩力 [N]	重量 [kg]	IP 等级
LI16	20 - 50	80 - 100	80	0,05 - 0,1	IP54
LI30	15 - 90	200 - 270	200	0,05 - 0,1	IP54
LI40	40 - 300	270 - 450	270	0,05 - 0,3	IP54
LI50	50 - 300	950	950	0,03 - 0,2	IP54

更多详情请上网查询



所有信息查询请点击:www.zimmer-group.com。产品参数、绘图、3D模型和操作说明均可根据产品型号查询。清晰且实时更新。

线性气缸

LI40 尺寸型号

▶ 产品规格



▶ 力和力矩

静态负荷下的最大动力和扭矩消耗。

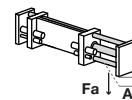

▶ 配件建议



能源供应



DRVM5X4
流量控制阀 - 转动式



传感器



NJ12-E2S
接近开关 - M8连接头



接口 / 其他



AP40
适配板



AD-M10X1
缓冲器



接口 / 其他



HV40
缓冲器安装支架



PHE14X15NSDE-A
工业缓冲器 PowerStop



KAG500
插入式直连接头电缆 5 m - M8插头(母头)



KAW500
插入式弯角连接头电缆 5 m - M8插头(母头)



ZE20H7X4
中心定位环

订购编号	▶ 技术数据	
	LI40-40	LI40-90
行程 [mm]	40	90
压力 [N]	450	450
最大收缩力 [N]	270	270
无负载时运行时间 [s]	0.08	0.2
额定操作气压 [bar]	6	6
最低操作温度 [°C]	5	5
最高操作温度 [°C]	+80	+80
每循环耗气体积 [cm ³]	50	117
重量 [kg]	0.81	1.2
Fa最大负载 [N]	80	30
最大偏移值A [mm]	0.05	0.05

