

2-JAW PARALLEL GRIPPERS WITH LONG STROKE SERIES GHK6000

▶ PRODUCT ADVANTAGES



“The robust”

- ▶ Securing the workpiece in case of drop in pressure above clamping element on the condition of a positive gripper jaw design
- ▶ Dimensions based on GH6000 series standard gripper
- ▶ Long stroke, up to 200 mm per jaw
- ▶ Stable T-slot guide, guided completely along the entire length of the housing
- ▶ For gripper fingers with a length of up to 600 mm
- ▶ Compact design, through stacked cylinder and guide

▶ THE BEST PRODUCT FOR YOUR APPLICATION





▶ TECHNICAL DRAWINGS

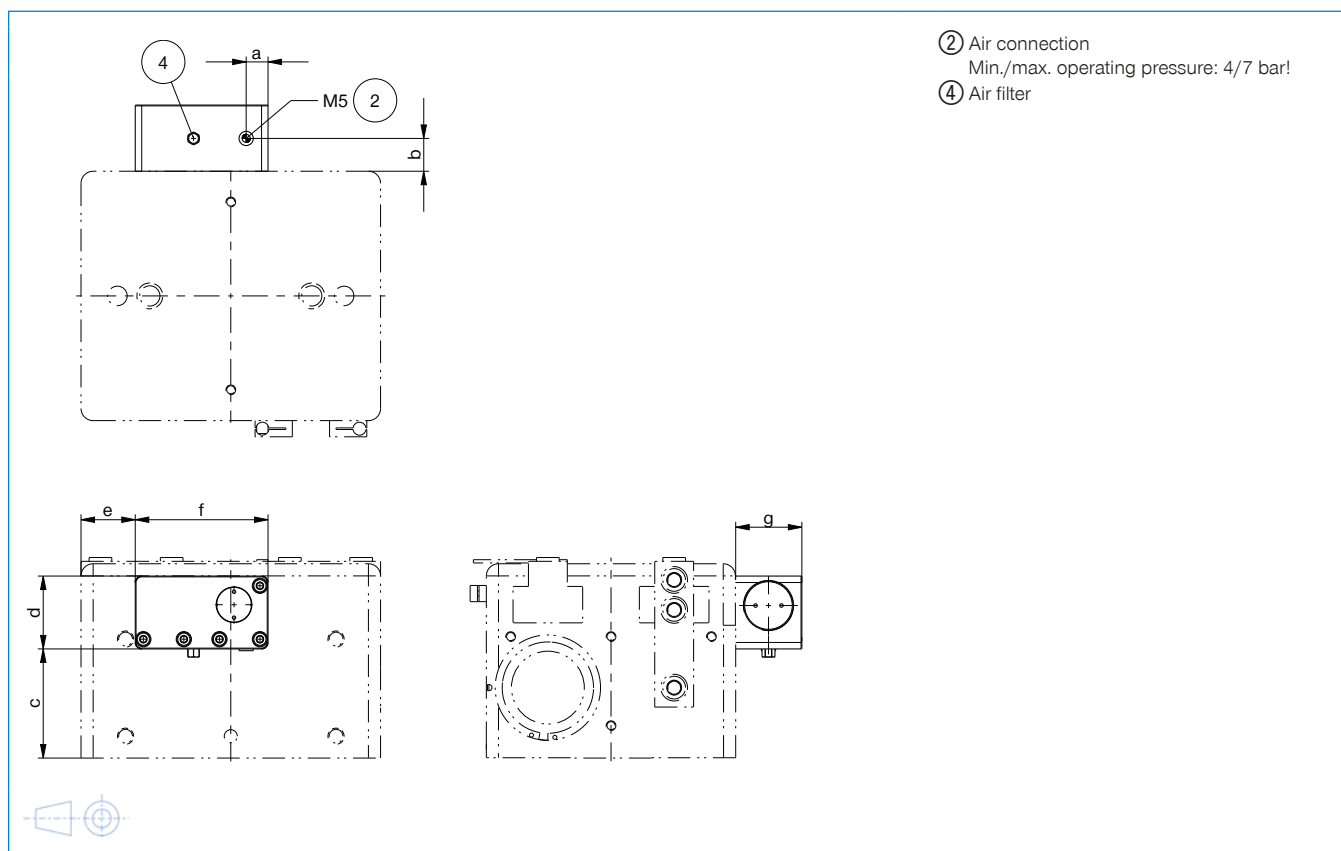

▶ TECHNICAL DATA

Installation size	Retention force in case of drop in pressure	A	B	C	D	E	F	G
	[N]	[mm]	[mm]	[mm]	[mm]	[mm]	[mm]	[mm]
GHK6140	300	9.6	11.5	21.7	25	17.5	58	22
GHK6160	300	9.6	11.5	21.7	25	37.5	58	22
GHK6180	300	9.6	11.5	21.7	25	57.5	58	22
GHK6240	640	15	14	39.5	35	20	66	27
GHK6260	640	15	14	39.5	35	40	66	27
GHK6280	640	15	14	39.5	35	60	66	27
GHK62100	640	15	14	39.5	35	80	66	27
GHK62150	640	15	14	39.5	35	130	66	27
GHK6360	640	15	14	56	35	47.5	66	27
GHK63100	640	15	14	56	35	87.5	66	27
GHK63150	640	15	14	56	35	137.5	66	27
GHK6460	1050	13.5	20.5	67.4	45	33.5	82	41
GHK64100	1050	13.5	20.5	67.4	45	73.5	82	41
GHK64150	1050	13.5	20.5	67.4	45	123.5	82	41
GHK64200	1050	13.5	20.5	67.4	45	173.5	82	41

▶ FURTHER INFORMATION IS AVAILABLE ONLINE



All information just a click away at: www.zimmer-group.com. Find data, illustrations, 3D models and operating instructions for your installation size using the order number for your desired product. Quick, clear and always up-to-date.

2-JAW PARALLEL GRIPPERS WITH LONG STROKE

INSTALLATION SIZE GH62100

▶ PRODUCT SPECIFICATIONS



▶ Gripping force diagram

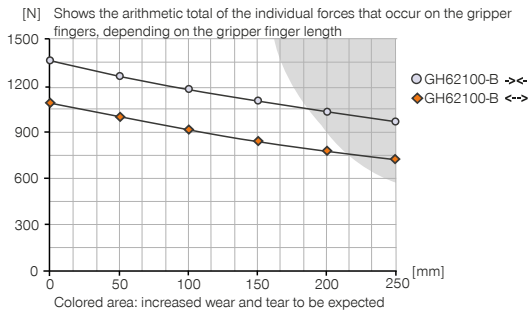

▶ Forces and moments

Displays static forces and moments that can also have an effect, besides the gripping force.



Mr [Nm]	160
Mx [Nm]	200
My [Nm]	140
Fa [N]	3000

▶ INCLUDED IN DELIVERY



2 [piece]
Mounting block
KB8-28



4 [piece]
Centering Disc
DST41000



2 [piece]
Flow Control Valves - with Swivel joint
DRV1-8X8

▶ YOU CAN FIND RECOMMENDED ACCESSORIES ON THE FOLLOWING PAGES

