

2-JAW ANGULAR GRIPPERS

SERIES GG1000

▶ PRODUCT ADVANTAGES

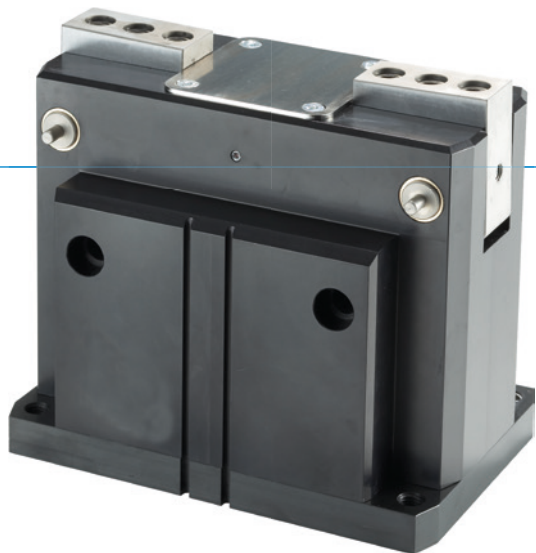

“The strong”

▶ High gripping force

Using the high gripping force, you can safely handle even the heaviest workpieces







▶ High moment load

The generously scaled angular gear box provides the highest possible durability for your application

▶ Failure-free continuous operation

Our uncompromising “Made in Germany” quality guarantees up to 10 million maintenance-free cycles

▶ SERIES CHARACTERISTICS

Installation size	Version	
	NC	FNC
GG1XXX		
 Gripper jaws with mounting possibility on the side		•
 Spring closing C	•	•
 10 million maintenance-free cycles (max.)	•	•
 Inductive sensor	•	•
 Magnetic field sensor	•	•
 Purged air	•	•
 IP40	•	•



► BENEFITS IN DETAIL

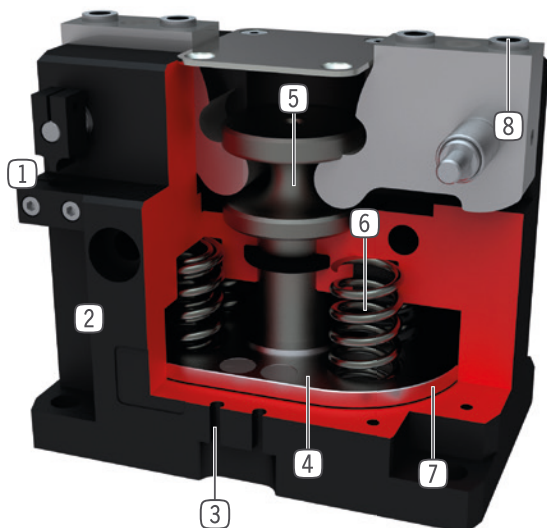

- ① **Cam-switch and mounting block**
 - for position sensing
- ② **Robust, lightweight housing**
 - Hard-coated aluminum alloy
- ③ **Sensing slot**
 - groove for positioning of the magnetic field sensor
- ④ **Permanent magnet**
 - sensing of the piston setting position via magnetic field sensors
- ⑤ **Positively driven lever mechanism**
 - synchronized the movement of the gripper jaws
- ⑥ **Integrated gripping force safety device**
 - spring integrated into cylinder as energy storage
- ⑦ **Drive**
 - double-acting pneumatic cylinder
- ⑧ **Removable centering sleeves**
 - quick and economical positioning of the gripper fingers

► TECHNICAL DATA

Installation size	Stroke [°]	Gripping force [N]	Weight [kg]	IP class
GG1065	20	2910 - 4160	1,3 - 1,4	IP40
GG1085	20	7120 - 9670	2,8 - 3,2	IP40
GG1110	20	18665 - 23240	6,3 - 6,7	IP40
GG1140	20	29110 - 36470	12,4 - 13	IP40

► FURTHER INFORMATION IS AVAILABLE ONLINE



All information just a click away at: www.zimmer-group.com. Find data, illustrations, 3D models and operating instructions for your installation size using the order number for your desired product. Quick, clear and always up-to-date.

2-JAW ANGULAR GRIPPERS

INSTALLATION SIZE GG1140

▶ PRODUCT SPECIFICATIONS



▶ Gripping force diagram

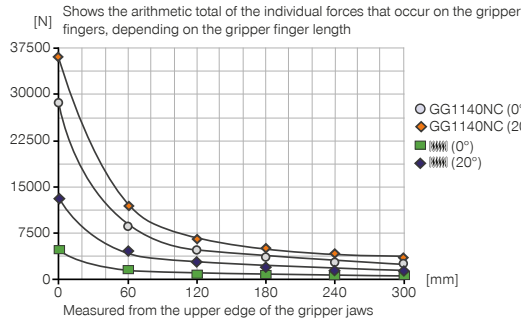

▶ Forces and moments

Displays static forces and moments that can also have an effect, besides the gripping force.

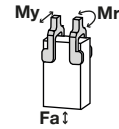

Mr [Nm]	110
My [Nm]	120
Fa [N]	1500

▶ INCLUDED IN DELIVERY



4 [piece]
Centering Disc
DST42000

▶ RECOMMENDED ACCESSORIES



ENERGY SUPPLY



GV1-4X8
Straight Fittings - Quick Connect Style



SENSORS



MFS01-S-KHC-P2-PNP
2-point sensor angled, cable 0.3 m - M8 connector



SENSORS



MFS02-S-KHC-P2-PNP
2-point sensor straight, cable 0.3 m - M8 connector



KB8-43
Mounting block



CONNECTIONS / OTHER



KHA1140-8
Alternate proximity bracket



HES0008
Stroke adjustment screw



NJ8-E2S
Inductive proximity switch - Connector M8



KAG500
Plug-in connector Straight Cable 5m - Socket M8 (female)



MFS01-S-KHC-P1-PNP
Magnetic field sensor angled, cable 0.3 m - M8 connector



KAW500
Plug-in connector Angled Cable 5m - Socket M8 (female)



MFS02-S-KHC-P1-PNP
Magnetic field sensor straight, cable 0.3 m - M8 connector



Order no.	▶ Technical data	
	GG1140NC	GG1140FNC
Stroke per jaw [°]	20	20
Gripping moment in closing max. [Nm]	725	725
Gripping moment secured by spring min. [Nm]	143	143
Gripping force in closing at 0° [N]	29110	29110
Gripping force in closing max. (at 20°) [N]	36470	36470
Gripping force secured by spring (at 0°) [N]	5740	5740
Gripping force secured by spring (at 20°) [N]	13110	13110
Closing time [s]	0.25	0.25
Opening time [s]	0.5	0.5
Repetition accuracy +/- [mm]	0.05	0.05
Operating pressure min. [bar]	4	4
Operating pressure max. [bar]	8	8
Nominal operating pressure [bar]	6	6
Operating temperature min. [°C]	5	5
Operating temperature max. [°C]	+80	+80
Air volume per cycle [cm³]	760	760
Protection to IEC 60529	IP40	IP40
Weight [kg]	12.4	13

