

3-JAW CONCENTRIC GRIPPERS

SERIES GED1300

▶ PRODUCT ADVANTAGES

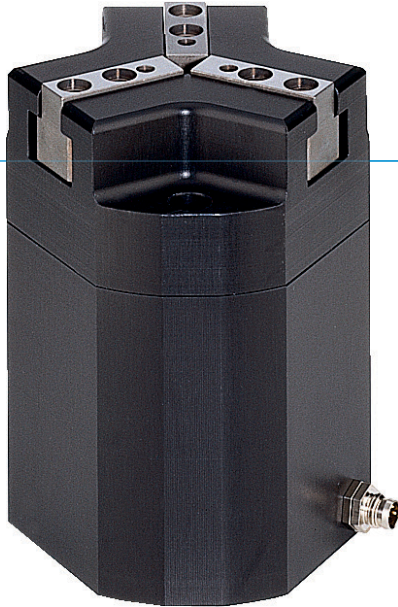

“The robust”

▶ Proven T slot guide

This established and proven guiding technology stands for the highest process reliability like no other





▶ Integrated position sensing

You can detect the gripper status safely via the motor current using your control system

▶ The simplest activation

The included control unit is controlled easily via plus and minus buttons, while you can optionally adjust the gripping force using the potentiometer

▶ SERIES CHARACTERISTICS

Installation size		Version		
GED130X			C	O
 Digital I/O		•	•	•
 External gripping			•	
 Internal gripping				•
 5 million maintenance-free cycles (max.)		•	•	•
 IP40		•	•	•



► BENEFITS IN DETAIL

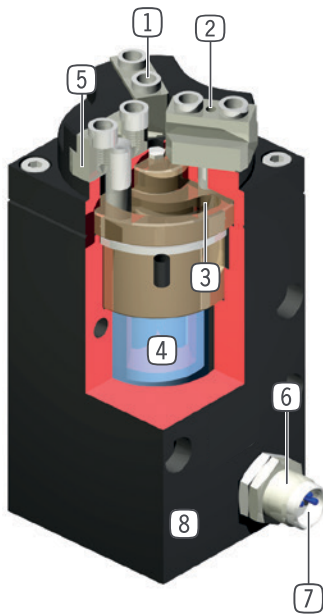

- ① **Removable centering sleeves**
 - quick and economical positioning of the gripper fingers
- ② **Gripper jaw**
 - hardened steel
 - individual gripper finger mounting
- ③ **Positively driven curve disc**
 - synchronized the movement of the gripper jaws
 - high force transfer
 - rapid stroke and force stroke (version with 6 mm stroke per jaw)
- ④ **Drive**
 - electric drive by 24 VDC step motor
- ⑤ **Guide**
 - precise T-Slot guide for high forces and moments capacity
- ⑥ **Position sensing**
 - measured at the end of stroke via power increase on the motor
- ⑦ **Energy supply**
 - standardized interface M8 round plug connection signal control line (use only cable without diode)
- ⑧ **Robust, lightweight housing**
 - Hard-coated aluminum alloy

► TECHNICAL DATA

	Stroke per jaw	Gripping force	Weight	IP class
Installation size	[mm]	[N]	[kg]	
GED1302	2	140	0.25	IP40
GED1306	6	350	1.7	IP40

► FURTHER INFORMATION IS AVAILABLE ONLINE



All information just a click away at: www.zimmer-group.com. Find data, illustrations, 3D models and operating instructions for your installation size using the order number for your desired product. Quick, clear and always up-to-date.

3-JAW CONCENTRIC GRIPPERS

INSTALLATION SIZE GED1302

▶ PRODUCT SPECIFICATIONS



▶ Gripping force diagram

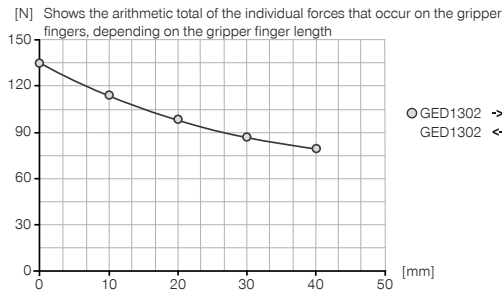

▶ Forces and moments

Displays static forces and moments that can also have an effect, besides the gripping force.



Mr [Nm]	5
Mx [Nm]	5
My [Nm]	4
Fa [N]	120

▶ INCLUDED IN DELIVERY



6 [piece]
Centering Disc
DST02900



1 [piece]
Control
ELEGR01

▶ RECOMMENDED ACCESSORIES



CONNECTIONS / OTHER



KAG500
Plug-in connector Straight Cable 5m - Socket M8 (female)



CONNECTIONS / OTHER



KAW500
Plug-in connector Angled Cable 5m - Socket M8 (female)



Order no.	Technical data
	GED1302
Stroke per jaw [mm]	2
Gripping force in closing (adjustable) max. [N]	140
Gripping force in opening (adjustable) max. [N]	140
Closing time [s]	0.2
Opening time [s]	0.2
Repetition accuracy +/- [mm]	0.1
Voltage [V]	24
Max. current regulable by potentiometer [mA]	140
Operating temperature min. [°C]	5
Operating temperature max. [°C]	+80
Protection to IEC 60529	IP40
Weight [kg]	0.25

