

AIR DAMPERS





SERIES QUIETO

▶ PRODUCT SPECIFICATIONS



This unit is designed for use in heavy-duty applications. Weights of up to 50 kg can be absorbed by just one damper.

▶ APPLICATION AREAS

 Door	
 Sliding door	•
 Drawer	•
 Hinge	

▶ SERIES CHARACTERISTICS

Series	Stroke [mm]	Medium	Operating direction
Quieto	70.0	Air	Pressure dampers

▶ TECHNICAL DRAWING

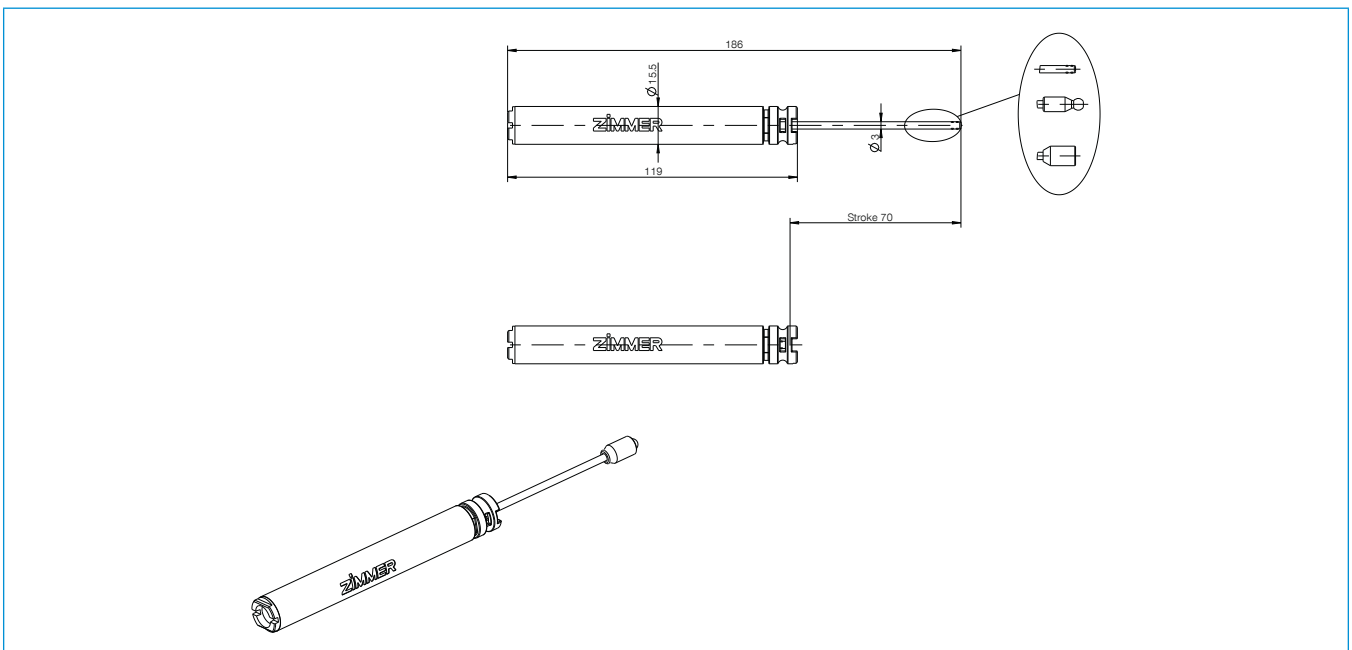

► TECHNICAL DATA

Order no.	A070-15-005
Mass to be braked [kg]	60.0
Damper Ø housing [mm]	15.5
Damper housing length [mm]	118.7
Damper Ø piston rod [mm]	3.0
Damper housing connection	Window
Damper piston rod connection	Ball head
Free-run	No
Free-run length [mm]	0.0
Damper reversal point [mm]	41.0
Damper reversal point tolerance [mm]	+9/-8
Damper closing time [s]	1.9
Damper closing time tolerance [s]	+0.6/-0.5
Damper housing color	Gray RAL7016
Damper cover color	Gray RAL7035

INDIVIDUAL DAMPERS

AIR FRICTION DAMPERS

PRINCIPLE OF FUNCTION

- ▶ In a sealed housing there is a piston which is moving back- and forward. By means of the pressure-difference which results within the closing-movement the sealing-lip will be pressed against the breaking-collar. This breaking-collar expand and presses the cylinder in which it moves. Thus the friction-energy is generated.
- ▶ No oil-leakage possible
- ▶ Friction force is related to the pressure

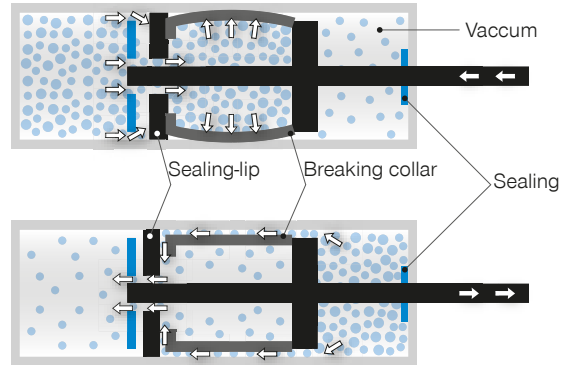

DAMPER WITH AND WITHOUT RESET-FUNCTION

Damper **without** reset-function needs a coupler onto the pistonrod is needed to be used within the fitting. The pistonrod do not extract by itself, it has to be extracted manually.



Damper **with** an integrated reset-function a Coupler is not needed onto the pistonrod within the fitting. The pistonrod will be extracted automatically.



GRAPH AIR FRICTION DAMPER IN SELF-CLOSING UNITS

Characteristic curve air friction damper

- Phase ① : sharp breakage
- Phase ② : short stop, returning point
- Phase ③ : dampened moving-in
- Phase ④ : unit closed

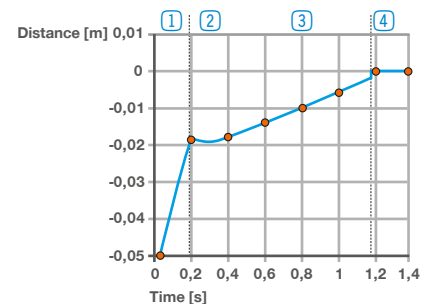

PRODUCT RANGE AIR-FRICTION DAMPER

- ▶ Housing length (l): 56 mm bis 164 mm
- ▶ Housing diameter (d): 9 mm bis 16,6 mm
- ▶ Stroke (s): 19 mm bis 110 mm

